

BKT
mobiliario
urbano

Ficha Técnica
Product Sheet

AS-009

Asiento Seat



La alta capacidad de configuración de este producto ofrece opciones que abarcan la elección de ciertos elementos. Esto permite adaptarse a una amplia gama de requisitos específicos del cliente, la ciudad y el usuario.

The high configurability of this product offers options covering the choice of certain elements. This makes it possible to adapt to a wide range of customer, city and user specific requirements.

Recto
Straight

Instalación
Installation

Dimensiones
Size



Taqueteable
Fastened

41 / 40 / 44 cm
16 / 15 / 17 in



Anclaje Químico
Chemical Anchor

41 / 40 / 44 cm
16 / 15 / 17 in

Curvo
Curved



Taqueteable
Fastened

43 / 45 / 44 cm
16.9 / 17.7 / 17 in



Anclaje Químico
Chemical Anchor

43 / 45 / 44 cm
16.9 / 17.7 / 17 in

Largo
Large



Taqueteable
Fastened

43 / 120 / 44 cm
16.9 / 47 / 17 in

AS-009



Asiento Seat

El AS-009 puede acomodarse de múltiples maneras, fijo a través de un anclaje o en algunos emplazamientos puede ser móvil sin anclaje. Este asiento está fabricado en concreto polimérico y puede producirse en diversos colores, justo para convivir con distintos sitios y entornos. Vemos a la ciudad en constante movimiento y este producto de reposo se adapta fácilmente a ello.

The city is in constant motion, and the AS-009 easily adapts. This award-winning versatile bench is made of polymer concrete and is suitable for public spaces. It can be arranged into shapes with straight or curved segments and comes in 5 colors.

Variables Variants

Forma Shape

- Recto Straight
- Curvo Curved

Peso (Recto): 55 kg

Peso (Curvo): 52 kg

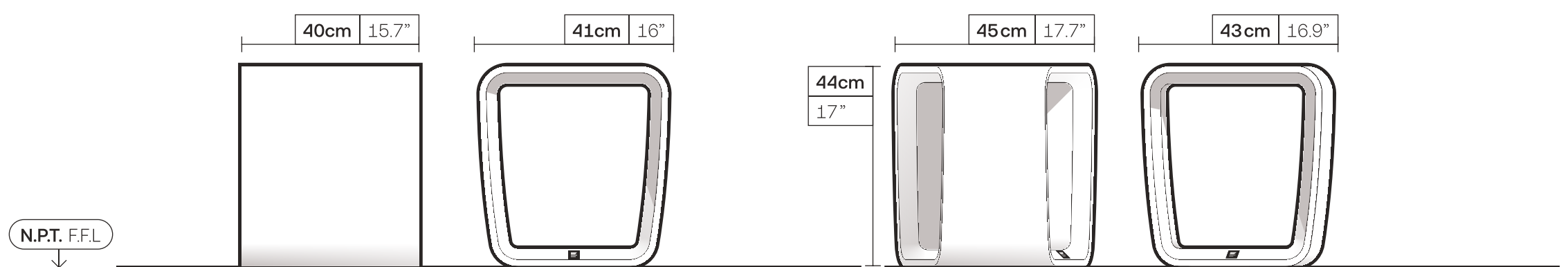

Apariencia Appearance

Cuerpo Body

- Concreto Polimérico Polymer Concrete

Configuraciones Settings

Tamaños Sizes

- Único Default

Instalación Installation

- Taqueteable Fastened
- Anclaje Químico Chemical Anchor

AS-009



Asiento Largo Large Seat

El AS-009 puede acomodarse de múltiples maneras, fijo a través de un anclaje o en algunos emplazamientos puede ser móvil sin anclaje. Este asiento está fabricado en concreto polimérico y puede producirse en diversos colores, justo para convivir con distintos sitios y entornos. Vemos a la ciudad en constante movimiento y este producto de reposo se adapta fácilmente a ello.

The city is in constant motion, and the AS-009 easily adapts. This award-winning versatile bench is made of polymer concrete and is suitable for public spaces. It can be arranged into shapes with straight or curved segments and comes in 5 colors.

Peso: 210 kg

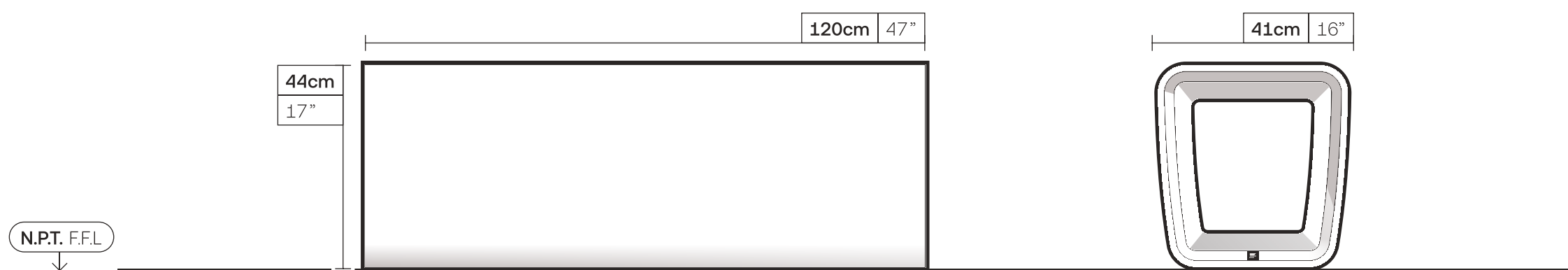

Apariencia Appearance

Cuerpo Body

- **Concreto Polimérico** Polymer Concrete

Configuraciones Settings

Tamaños Sizes

- **Único** Default

Instalación Installation

- **Taqueteable** Fastened
- **Anclaje Químico** Chemical Anchor

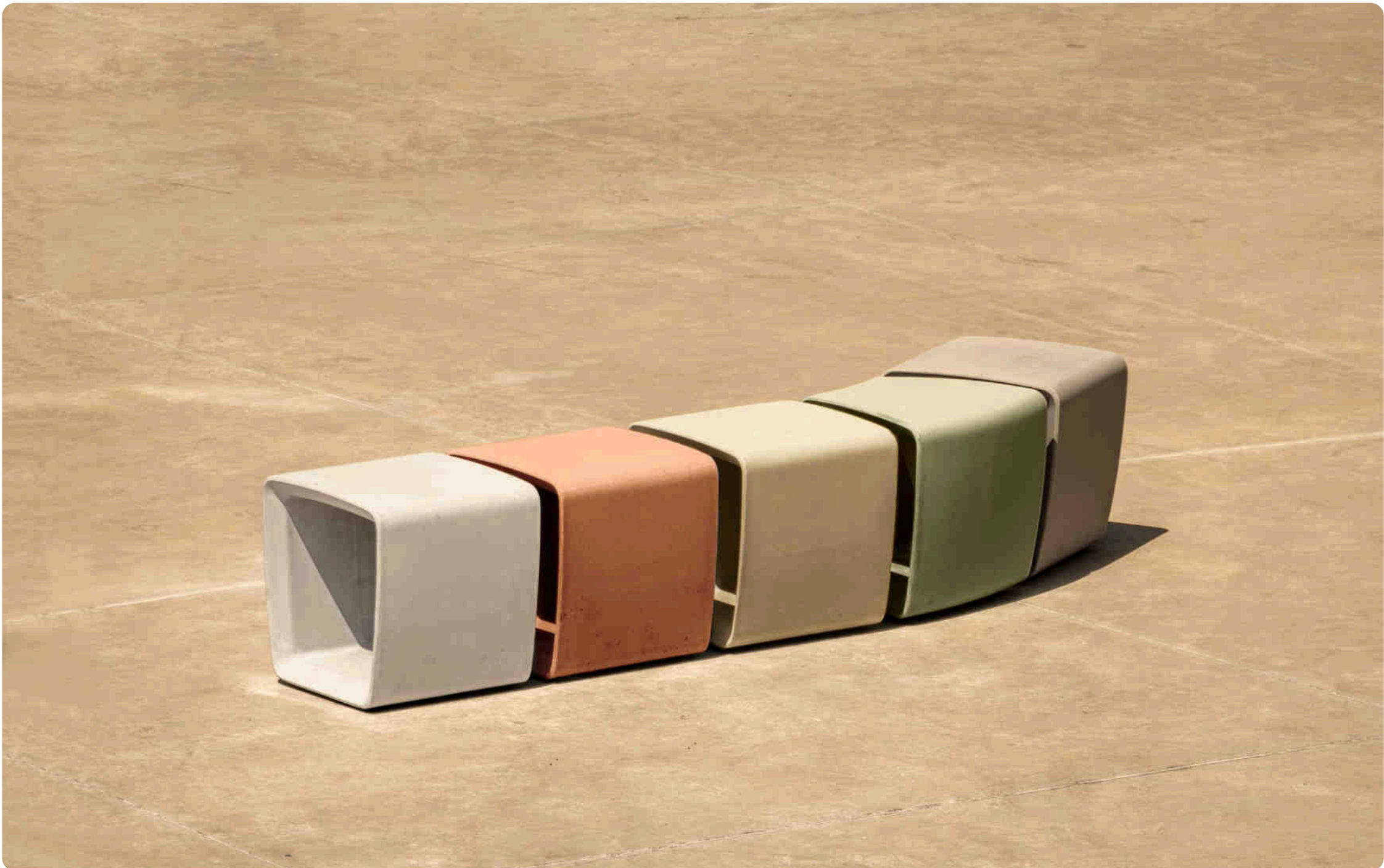

Configuraciones

Configurations

Recto
Straight

N. de asientos
Seats number

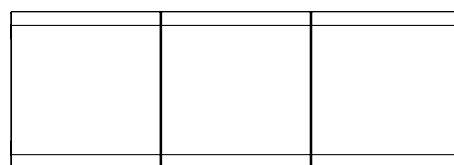
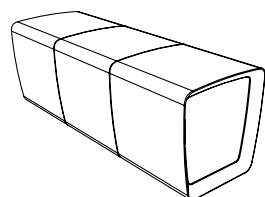

3

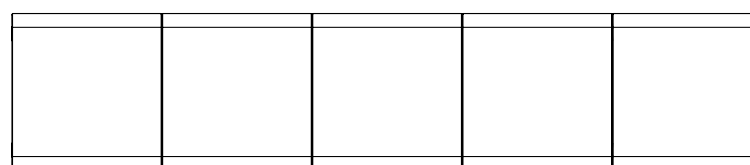
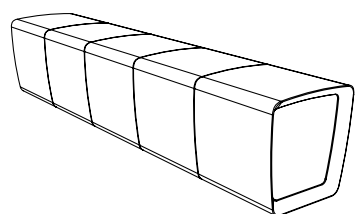

5

Curvo
Curved

N. de asientos
Seats number

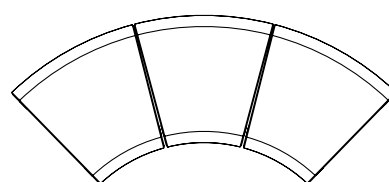
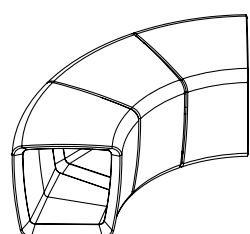

3

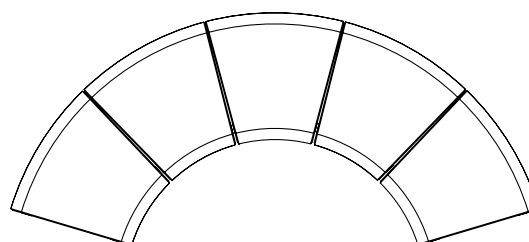
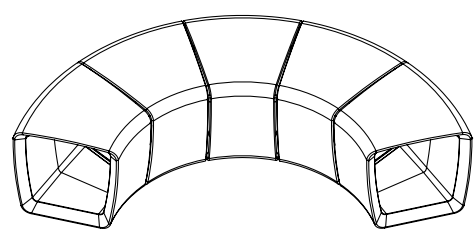

5

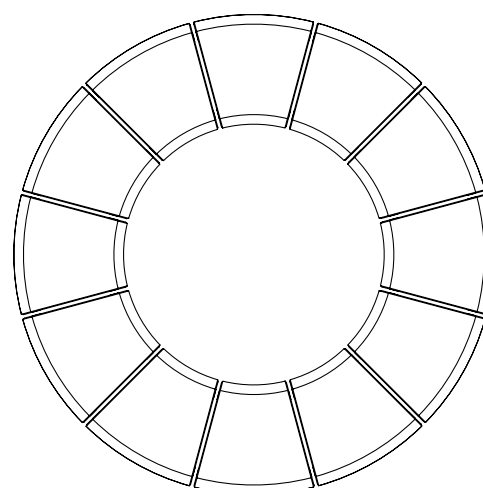
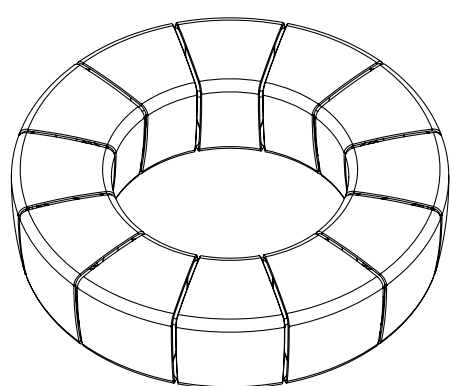

12

Para más información sobre las garantías, encuentralas en nuestro sitio web.

For more information about the warranties, find them on our website.

Garantías

Guarantees



Zona Urbana

Urban Area

Se refiere a zonas de baja polución, secas y frías, de baja humedad o algunas zonas desérticas.

It refers to areas of low pollution, dry and cold, low humidity or some desert areas.



Brisa Marina

Sea Breeze

Se refiere a embarcaderos o malecones con brisa de un grado muy alto de salinidad y neblina marina.

It refers to piers or promenades with very high levels of salt fog.



Alta Humedad

High Humidity

Se refiere a zonas húmedas sin niebla salina o con grado medio de salinidad con cercanía a la costa.

It refers to humid areas without salt fog or with a medium degree of salinity close to the coast.

Concreto Polimérico

Polymer Concrete



 120 meses months

 120 meses months

 60 meses months



 [bkt_mobiliario.urbano](https://www.instagram.com/bkt_mobiliario.urbano)

[bktmobiliario.com](https://www.bktmobiliario.com)

 Herrera y Cairo 980
Col. Jesús 44200
Guadalajara, Jal. MX

 MiBici GDL-10
 L1, Estación Refugio

 +52 33 3825 7333
+52 33 3165 8582

 info@bktmobiliario.com